



US00D517130S

(12) **United States Design Patent** (10) **Patent No.:** **US D517,130 S**
Orr (45) **Date of Patent:** **** Mar. 14, 2006**

(54) **PAINTBALL MARKER RECEIVER**

FOREIGN PATENT DOCUMENTS

(76) Inventor: **Jeffrey G. Orr**, 3779 Trinity Cir.,
Corona, CA (US) 92881

DE	19518884	6/1994
FR	2801567	10/1999
GB	2252302	8/1992
GB	2370027	6/2002
GB	2391292	2/2004

(**) Term: **14 Years**

(21) Appl. No.: **29/211,053**

(22) Filed: **Aug. 9, 2004**

(51) **LOC (8) Cl.** **21-01**

(52) **U.S. Cl.** **D21/573**

(58) **Field of Classification Search** D21/567,
D21/570, 572-575; D22/100, 103, 104, 108,
D22/109, 115; 124/56, 65, 70-74, 76, 77
See application file for complete search history.

Primary Examiner—Holly Baynham
Assistant Examiner—Cynthia M. Chin

(74) *Attorney, Agent, or Firm*—Keisling Pieper & Scott
PLC; David B. Prepeu; Trent C. Keisling

(57) **CLAIM**

The ornamental design for a paintball marker receiver, as shown and described.

(56) **References Cited**

DESCRIPTION

U.S. PATENT DOCUMENTS

43,573 A	7/1864	Crane	15/104.18
57,846 A	9/1866	Bausman	15/104.16
143,139 A	9/1873	Gould	15/104.16
645,932 A	3/1900	Ferrant	89/125
1,167,178 A	1/1916	Hill	124/56
1,343,127 A	6/1920	Hallinan	124/54
1,743,576 A	1/1930	Smith	124/72
2,453,683 A	11/1948	Caldow	42/70
2,484,267 A	10/1949	Bower	15/242
2,550,887 A	5/1951	Tratsch	124/1
2,563,720 A	8/1951	Guisasola	42/70
2,568,432 A	9/1951	Cook	124/13
2,834,332 A	5/1958	Guthrie	124/13

FIG. 1 is a top left perspective view of a paintball marker receiver showing my new design;
FIG. 2 is a left side elevational view thereof;
FIG. 3 is a front elevational view thereof;
FIG. 4 is a back elevational view thereof;
FIG. 5 is a right side elevational view thereof;
FIG. 6 is a top plan view thereof;
FIG. 7 is a bottom plan view thereof; and,
FIG. 8 is a reduced scale distal left elevational view thereof.
The broken lines in the drawings are for illustrative purposes only and form no part of the claimed design.

(Continued)

1 Claim, 6 Drawing Sheets

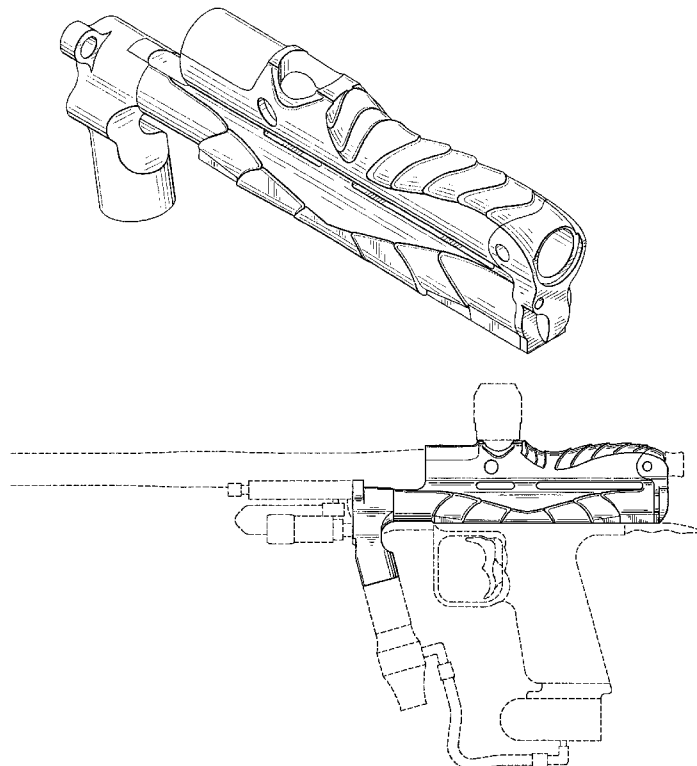

US D517,130 S

Page 2

U.S. PATENT DOCUMENTS

2,845,055 A	7/1958	Collins et al.	124/11	5,890,479 A	4/1999	Morin	124/31
3,089,476 A	5/1963	Wolverton	124/11	5,913,303 A	6/1999	Kotsiopoulos	124/31
3,240,200 A	3/1966	Jones	124/11	5,957,119 A	9/1999	Perry et al.	124/73
3,273,553 A	9/1966	Doyle	124/3	5,967,133 A	10/1999	Gardner, Jr.	124/77
3,374,708 A	3/1968	Wall et al.	89/1	6,003,504 A	12/1999	Rice et al.	124/73
3,494,344 A	2/1970	Vadas et al.	124/11	6,015,058 A	1/2000	Parks	220/229
3,548,708 A	12/1970	Hubigh	89/1,818	6,035,843 A	3/2000	Smith et al.	124/77
3,572,310 A	3/1971	Chiba	124/11	D423,609 S	* 4/2000	D'Andrade et al.	D21/572
3,695,246 A	10/1972	Filippi et al.	124/11	6,048,280 A	4/2000	Palmer et al.	473/416
3,818,887 A	6/1974	Akiyama et al.	124/15	6,055,975 A	5/2000	Gallagher et al.	124/50
3,899,845 A	8/1975	Wild et al.	42/69	6,065,460 A	5/2000	Lotuaco, III	124/72
D237,678 S	11/1975	Spencer	D7/179	D429,779 S	* 8/2000	Yu	D21/572
3,923,033 A	12/1975	Laporte et al.	124/8	D432,617 S	* 10/2000	Bechtel	D22/108
4,066,000 A	1/1978	Rostocil	89/198	6,138,656 A	10/2000	Rice et al.	124/73
4,133,128 A	1/1979	Brush	42/70 R	6,142,137 A	11/2000	MacLaughlin	124/72
4,207,799 A	6/1980	Tocco	89/196	6,212,812 B1	4/2001	Aigner	42/70.06
4,282,795 A	8/1981	Beretta	89/148	6,223,460 B1	5/2001	Schmitter et al.	124/70.06
4,347,679 A	9/1982	Grunig et al.	42/84	6,256,917 B1	7/2001	Findlay	42/70.06
4,362,145 A	12/1982	Stelcher	124/32	6,260,821 B1	7/2001	Perry et al.	251/314
4,516,273 A	5/1985	Gregory et al.	2/2	6,311,682 B1	11/2001	Rice et al.	124/71
4,589,327 A	5/1986	Smith	89/148	6,349,711 B1	2/2002	Perry et al.	124/73
4,602,608 A	7/1986	Lacam et al.	124/74	D454,685 S	3/2002	Parks et al.	D3/254
D286,900 S	* 11/1986	Barthropp	D21/573	6,382,200 B1	5/2002	Levkov	124/73
4,679,487 A	7/1987	Houseman	89/140	D458,333 S	6/2002	Power	D22/108
4,694,815 A	9/1987	Hung	124/27	D460,502 S	7/2002	Traum et al.	D21/573
4,770,153 A	9/1988	Edelman	124/72	6,439,217 B1	8/2002	Shih	124/77
4,779,245 A	10/1988	Chelminski	367/144	6,474,325 B1	11/2002	Rice et al.	124/71
4,785,930 A	11/1988	Fischer et al.	206/3	6,474,326 B1	11/2002	Smith et al.	124/77
4,819,609 A	4/1989	Tippmann	124/72	6,494,194 B1	12/2002	Shipachev et al.	124/73
4,899,717 A	2/1990	Rutten et al.	124/67	6,494,195 B1	12/2002	Perry et al.	124/84
4,936,282 A	6/1990	Dobbins et al.	124/74	6,532,949 B1	3/2003	McKendrick	124/77
4,940,138 A	7/1990	Hornstein	206/218	D473,910 S	4/2003	Rice et al.	D22/108
D321,325 S	11/1991	Petrus	D9/435	6,550,468 B1	4/2003	Tippmann, Jr.	124/71
5,063,905 A	11/1991	Farrell	124/72	6,553,983 B1	4/2003	Li	124/73
5,068,990 A	12/1991	Marzocco	42/70.04	6,578,566 B1	6/2003	Hernandez	124/73
5,078,118 A	1/1992	Perrone	124/74	6,590,386 B1	7/2003	Williams	324/178
5,149,898 A	9/1992	Chesnut et al.	42/69.01	6,615,814 B1	9/2003	Rice et al.	124/71
5,228,427 A	7/1993	Gardner, Jr.	124/71	6,626,165 B1	9/2003	Bhogal	124/77
5,251,533 A	10/1993	Layton	89/142	6,629,379 B1	10/2003	Doiron	42/70.11
5,261,384 A	11/1993	Hu	124/66	6,637,420 B1	10/2003	Moritz	124/73
5,280,778 A	1/1994	Kotsiopoulos	124/73	6,637,421 B1	10/2003	Smith et al.	124/77
5,282,454 A	2/1994	Bell et al.	124/49	6,644,295 B1	11/2003	Jones	124/77
5,293,708 A	3/1994	Strayer et al.	42/75.03	6,644,296 B1	11/2003	Gardner, Jr.	124/77
5,349,939 A	9/1994	Perrone	124/76	6,658,982 B1	12/2003	Cherry	89/1.42
5,363,834 A	11/1994	Stuchlik	124/76	D484,926 S	1/2004	Rice et al.	D21/573
5,370,105 A	12/1994	Firman	124/56	6,694,963 B1	2/2004	Taylor	124/32
5,413,083 A	5/1995	Jones	124/32	6,705,036 B1	3/2004	Orr	42/69.01
5,462,042 A	10/1995	Grenwell	124/76	6,725,852 B1	4/2004	Yokota et al.	124/49
D366,514 S	1/1996	Hochstrate et al.	D22/108	6,729,497 B1	5/2004	Rice et al.	220/835
5,503,137 A	4/1996	Fusco	124/72	6,739,322 B1	5/2004	Rice et al.	124/49
5,596,162 A	1/1997	Burns	89/128	6,748,938 B1	6/2004	Rice et al.	124/77
5,613,483 A	3/1997	Lukas et al.	124/73	6,763,822 B1	7/2004	Styles	124/77
5,634,456 A	6/1997	Perrone	124/76	D496,556 S	9/2004	Skrocki et al.	D7/391
5,635,663 A	6/1997	Krieger et al.	89/142	6,802,305 B1	10/2004	Hatcher	124/31
D385,586 S	* 10/1997	Hanatani et al.	D14/418	6,802,306 B1	10/2004	Rice	124/74
5,718,074 A	2/1998	Keeney	42/69.03	2003/0121927 A1	7/2003	Rice et al.	220/833
D393,115 S	3/1998	Bell et al.	D32/35	2003/0131514 A1	7/2003	Rice et al.	42/69.01
5,727,538 A	3/1998	Ellis	124/77	2003/0131834 A1	7/2003	Rice et al.	124/32
5,736,720 A	4/1998	Bell et al.	235/1	2003/0154968 A1	8/2003	Rice et al.	124/71
5,755,213 A	5/1998	Gardner, Jr. et al.	124/73	2003/0178018 A1	9/2003	Cherry	124/76
5,760,328 A	6/1998	Robbins	89/129.02	2003/0221684 A1	12/2003	Rice	124/71
5,799,434 A	9/1998	Krieger et al.	42/69.03	2004/0011344 A1	1/2004	Rice et al.	124/73
5,816,232 A	10/1998	Bell	124/51.1	2004/0031836 A1	2/2004	Garcia	224/665
5,868,637 A	2/1999	Poxon	473/469	2004/0074489 A1	4/2004	Neumaster et al.	124/79
5,878,736 A	3/1999	Lotuaco, III	124/71	2004/0084040 A1	5/2004	Jones	124/77
5,881,707 A	3/1999	Gardner, Jr.	124/77				

* cited by examiner

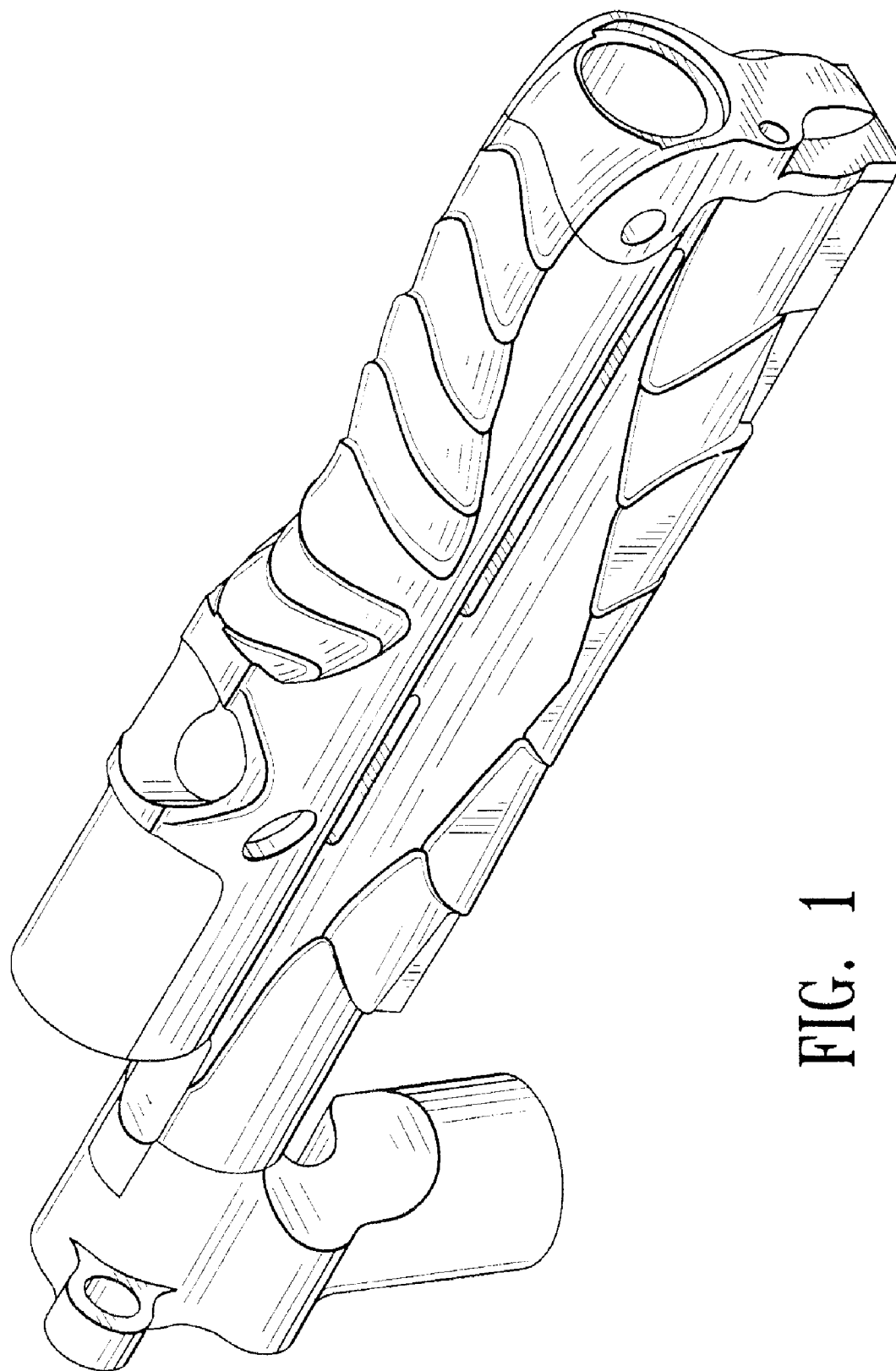

FIG. 1

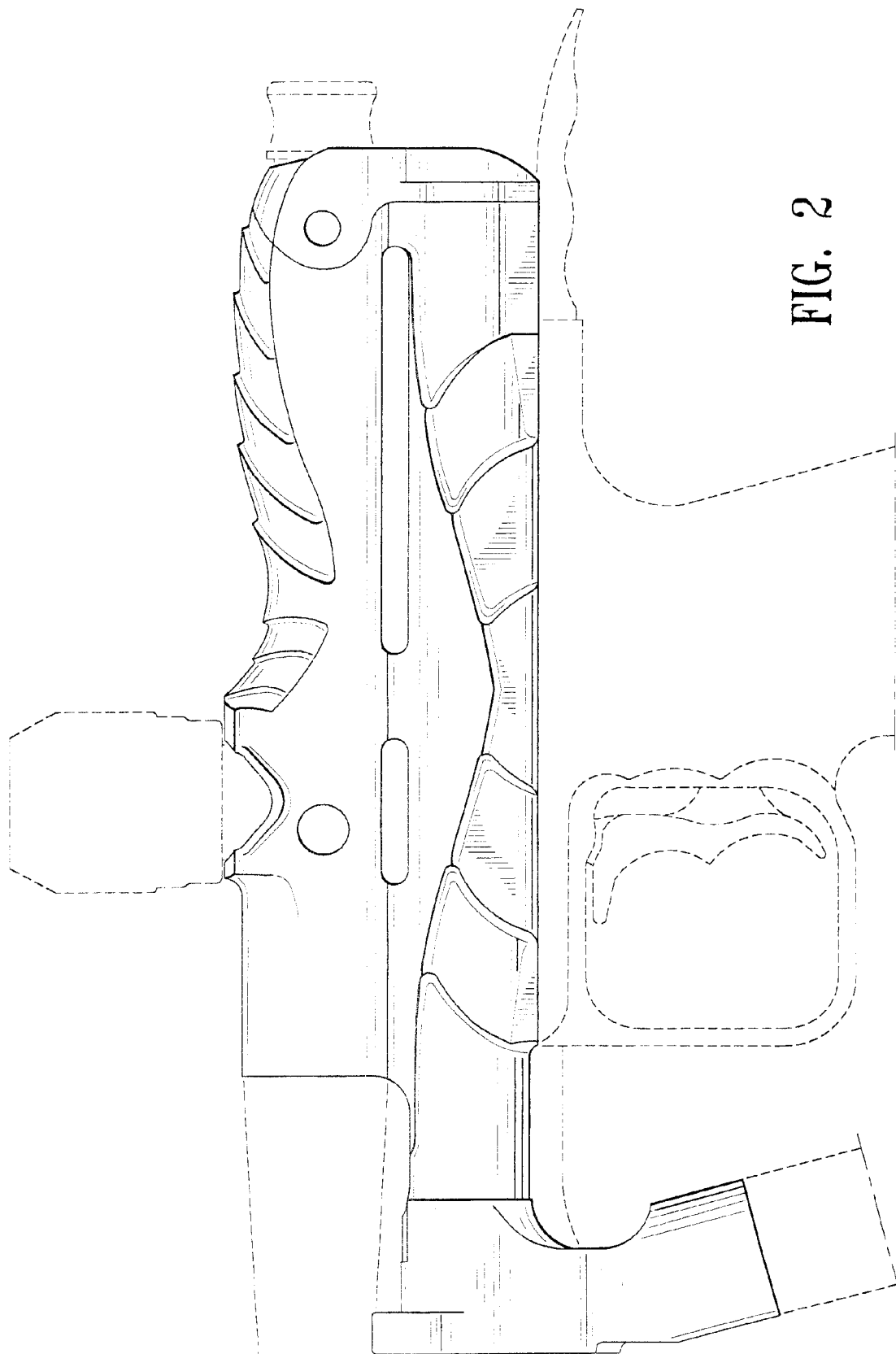

FIG. 2

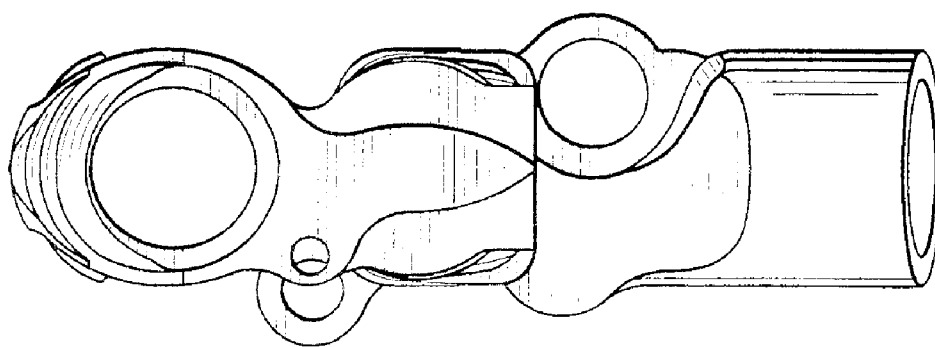

FIG. 4

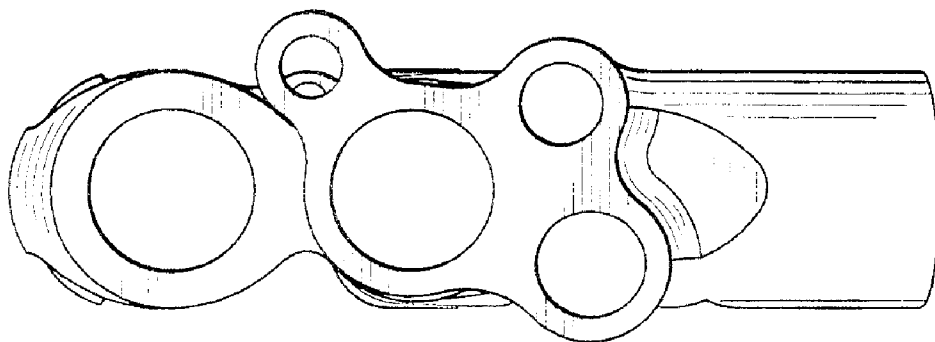

FIG. 3

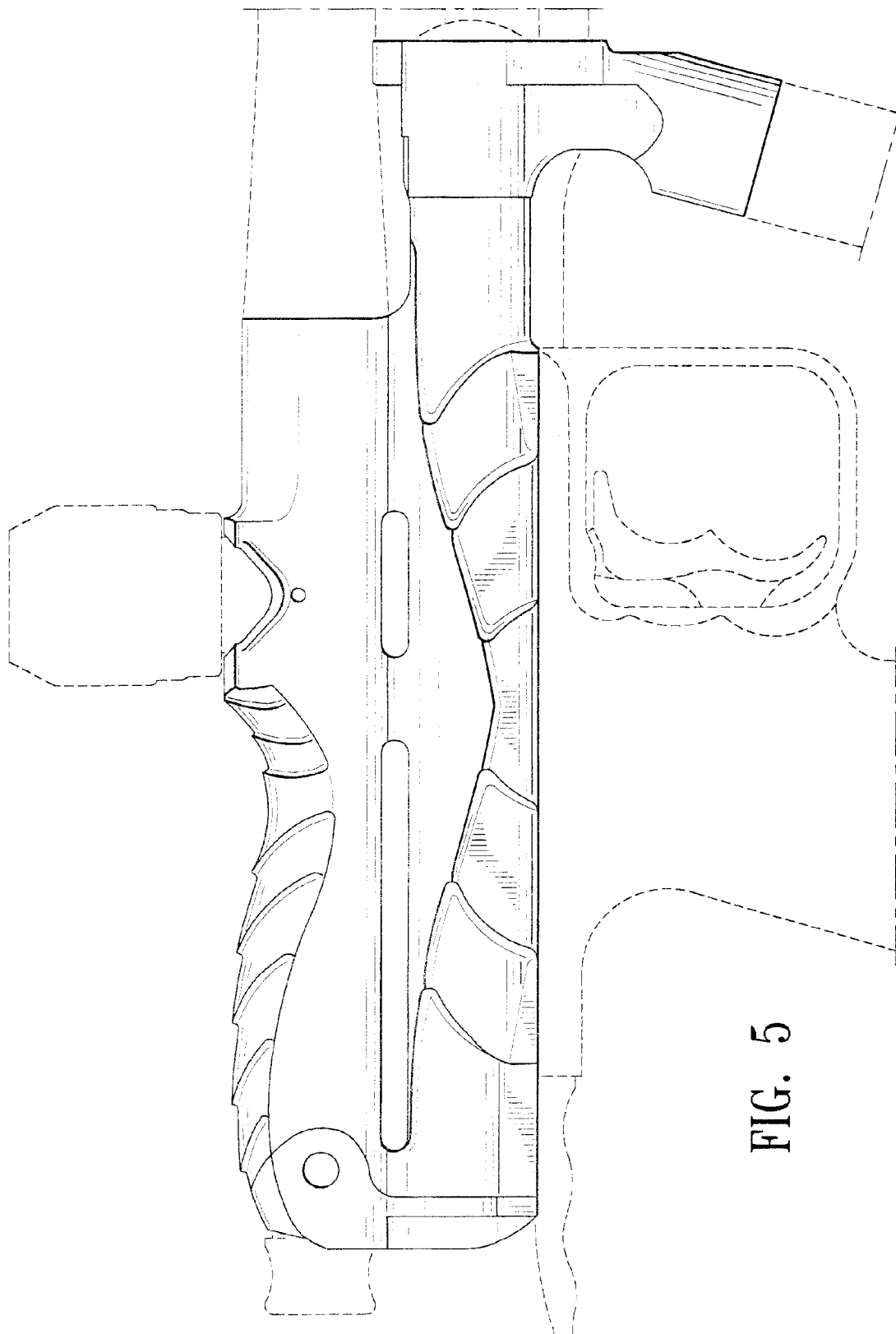

FIG. 5

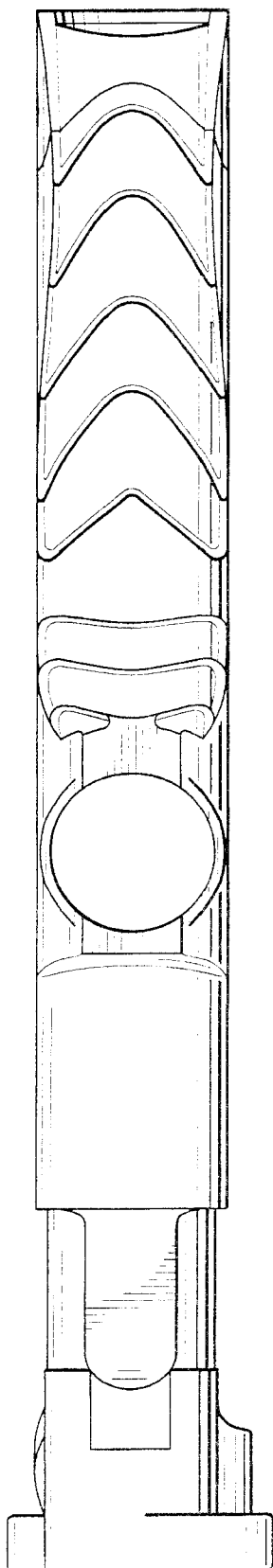

FIG. 6

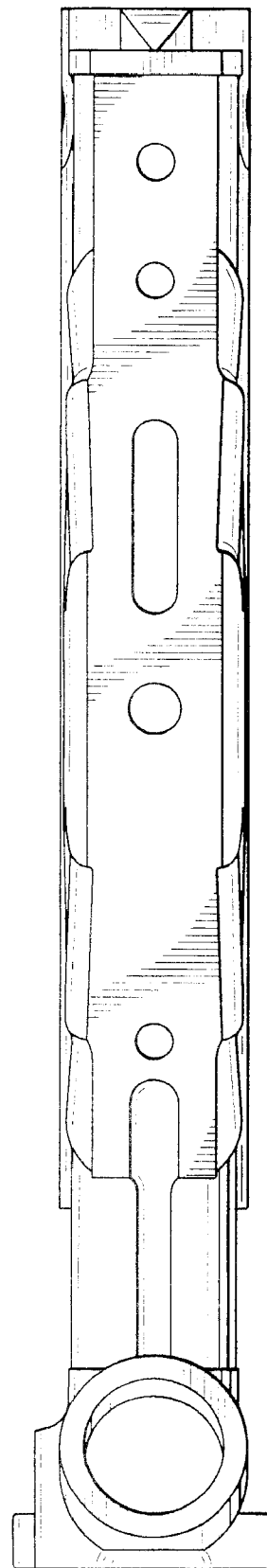

FIG. 7

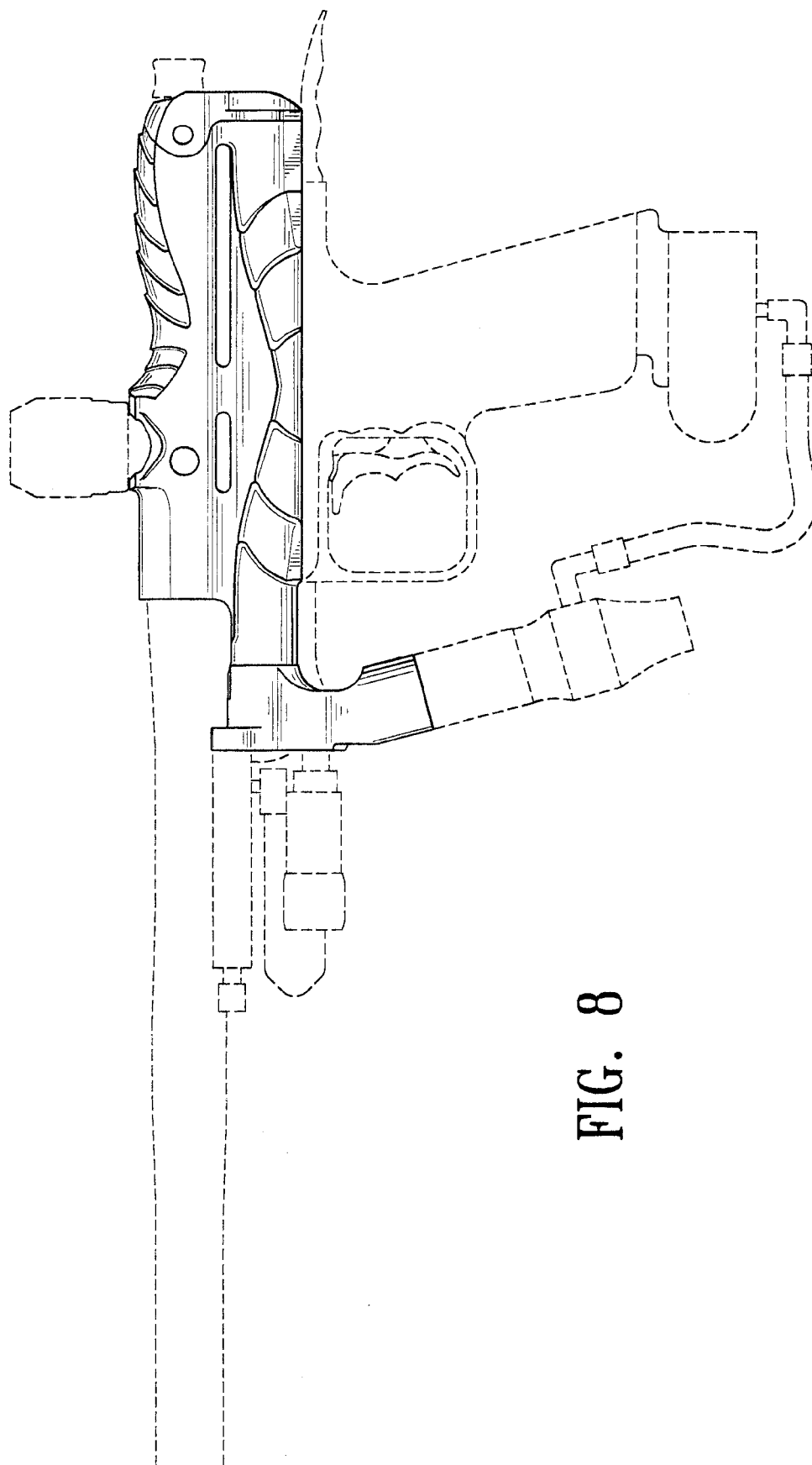

FIG. 8